

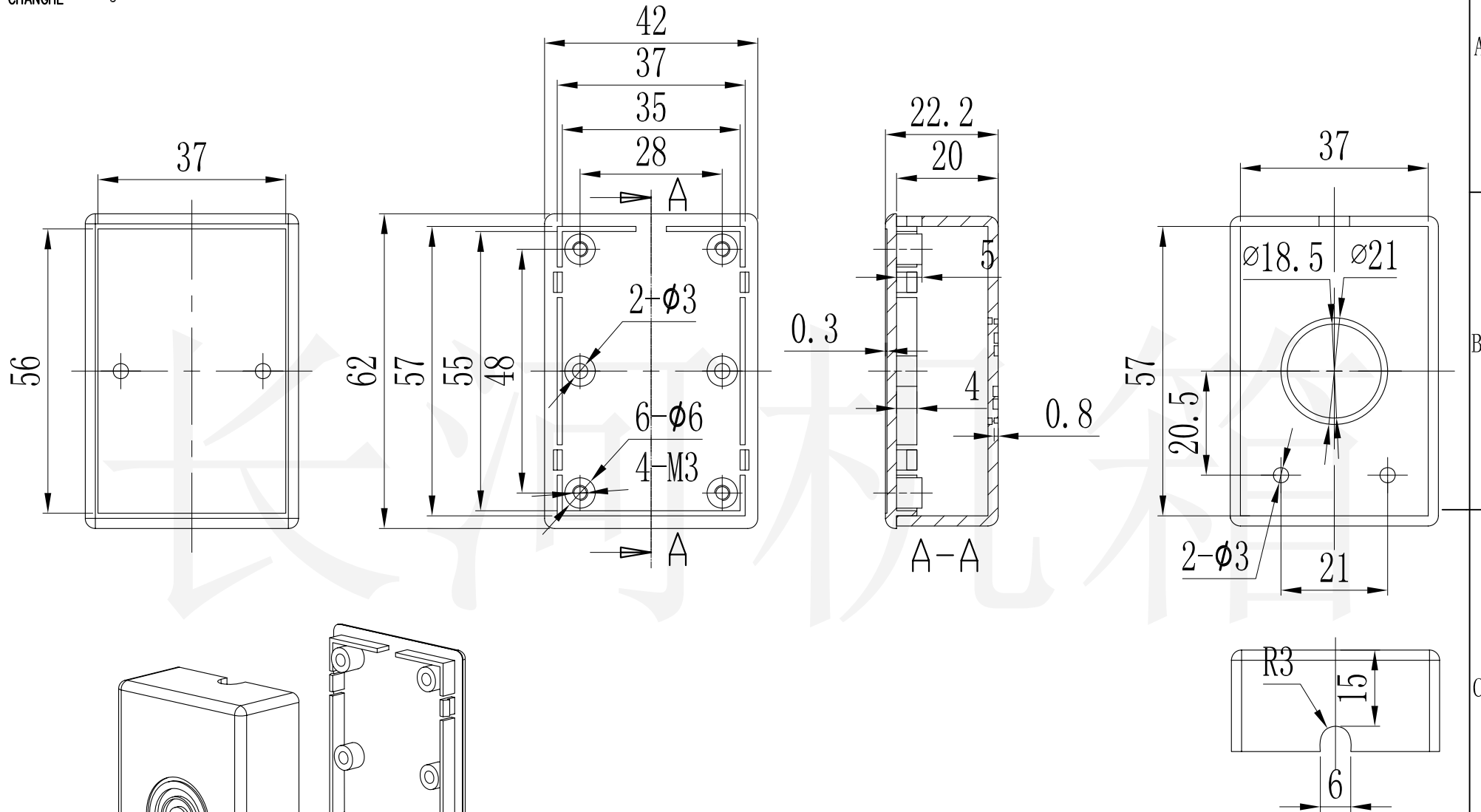

长河机箱
Changhe Enclosures

<http://www.enclosures.com.cn>



底图总号

D

旧底图总号

日期

签字

制图 Drawing	审核 Auditing	批准 Confirm	产品名称 Product Name	非标塑壳 special plastic enclosure	材料 Material	ABS
			产品编号 Product Code	18-162	视图 Project View	(m m)
					图纸比例 Drawing Scale	
共 张 第 张			宁波大洋壳体有限公司 Ningbo Dayang Enclosures CO., LTD			